

One Bindery Copy exists for each copy on order for each component.

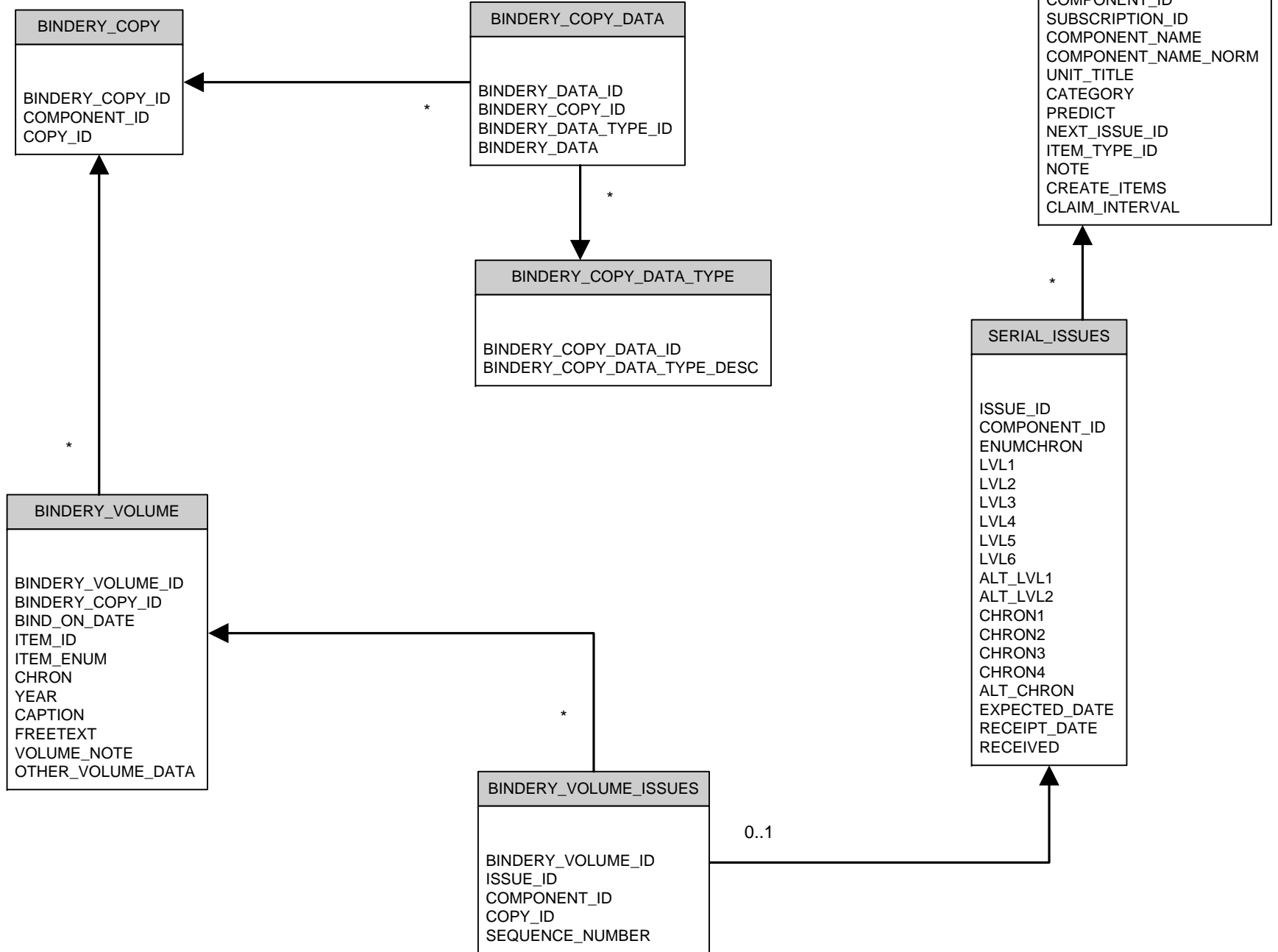

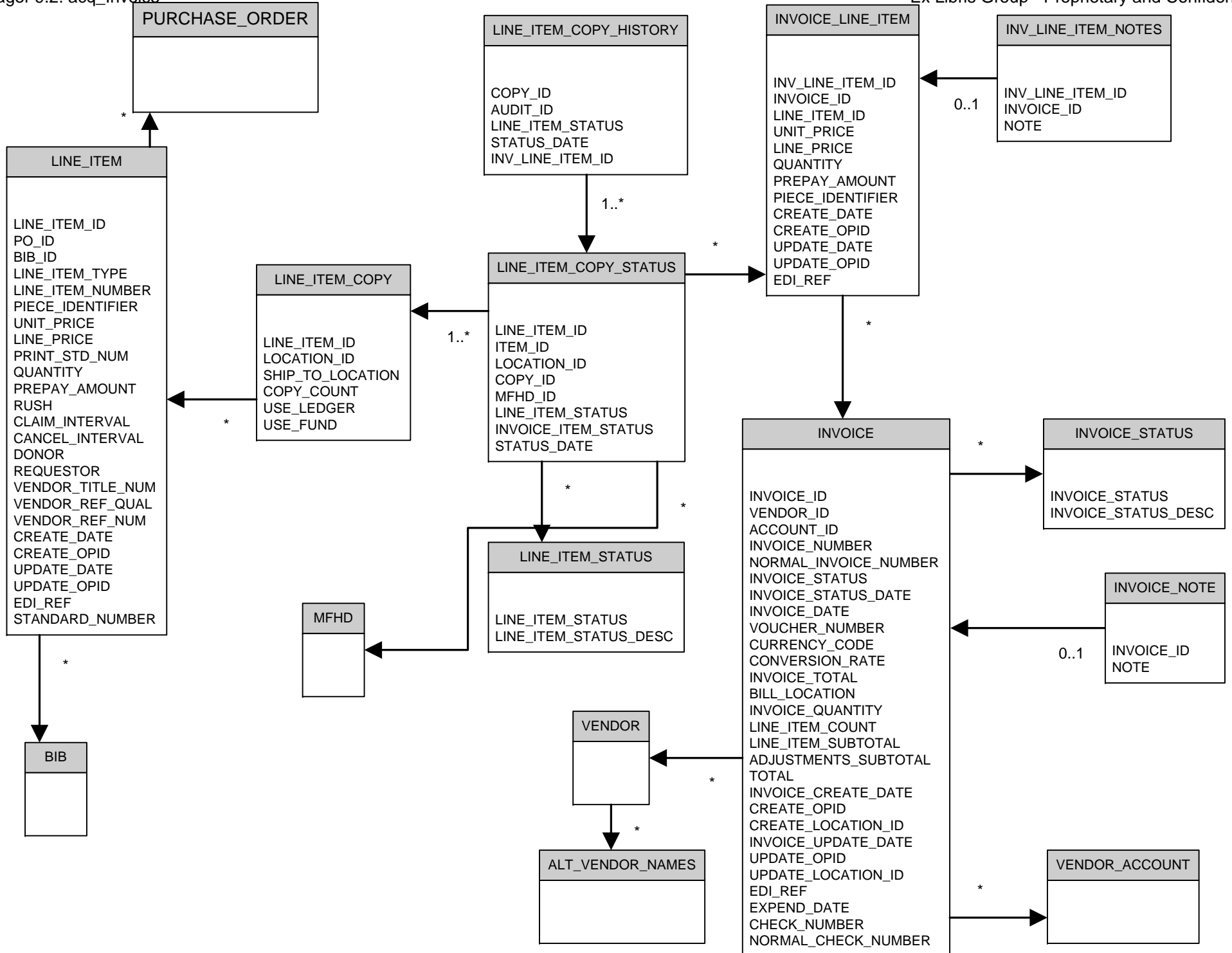

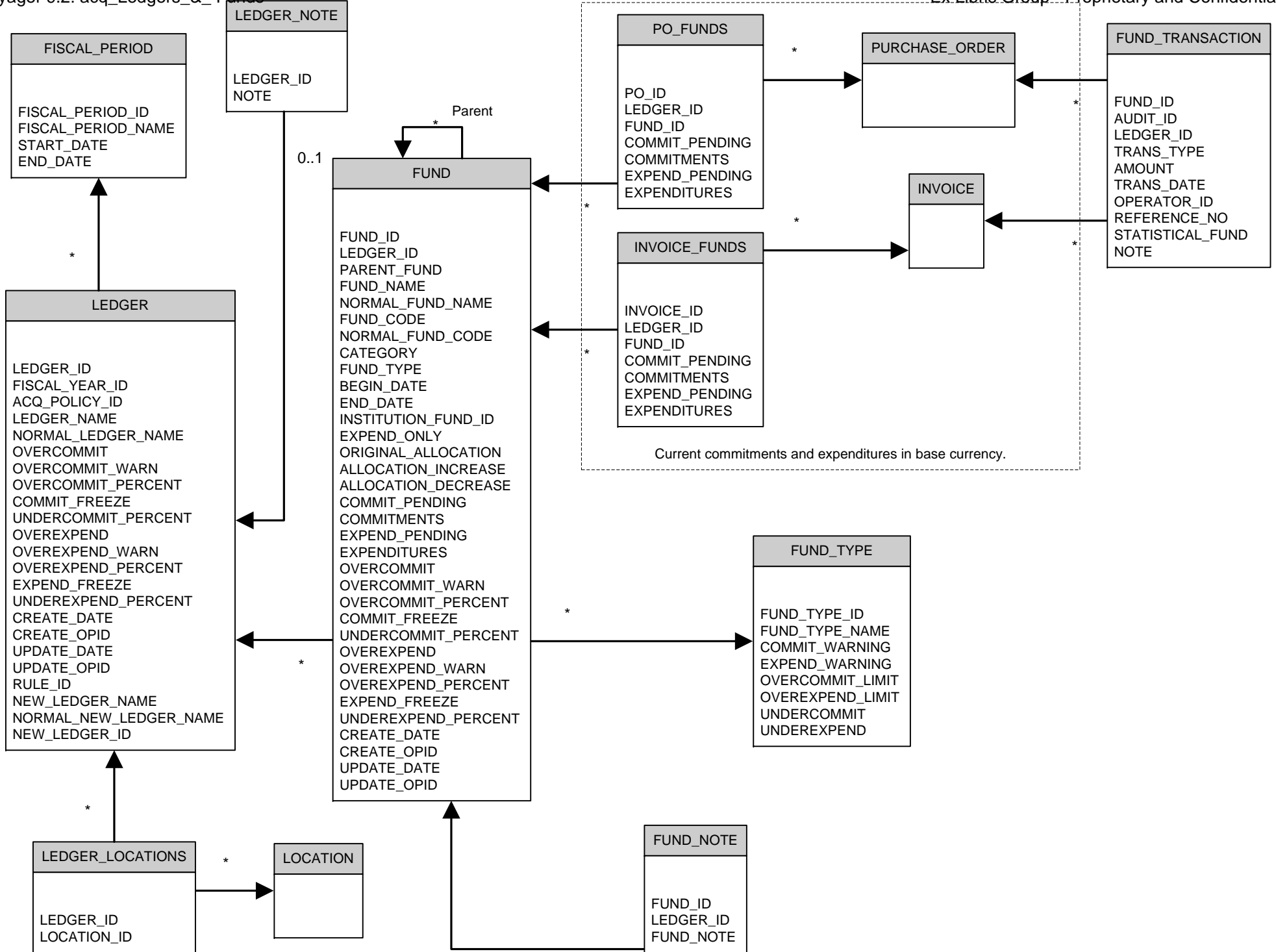

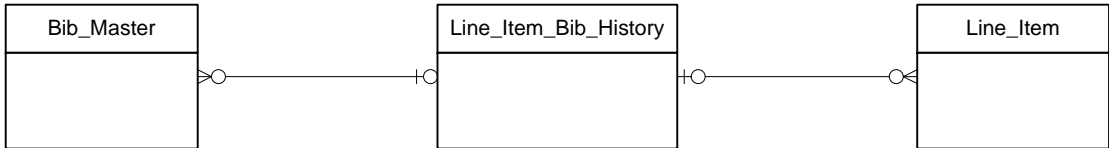

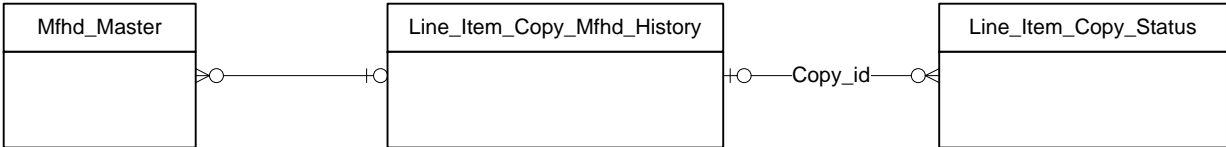

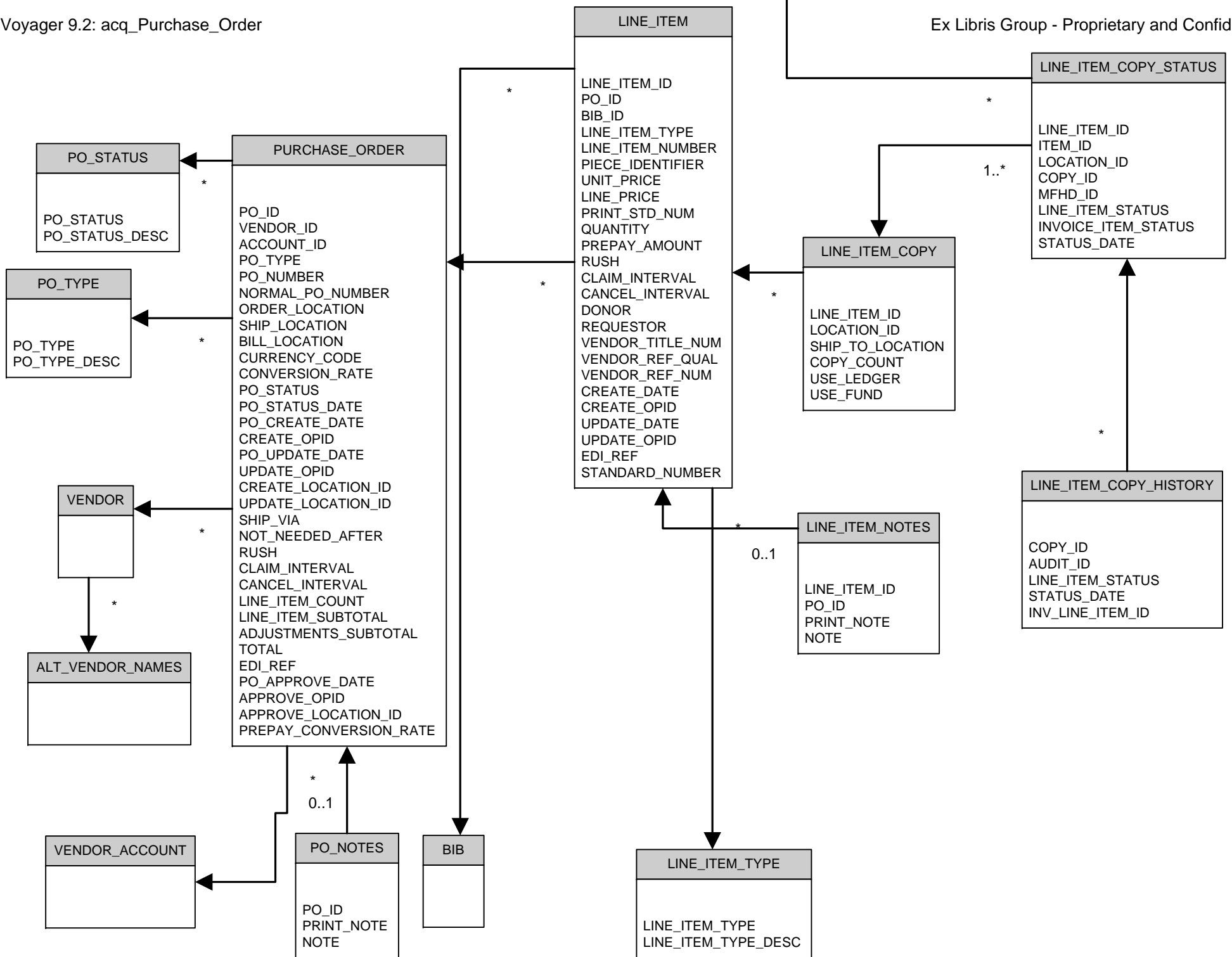

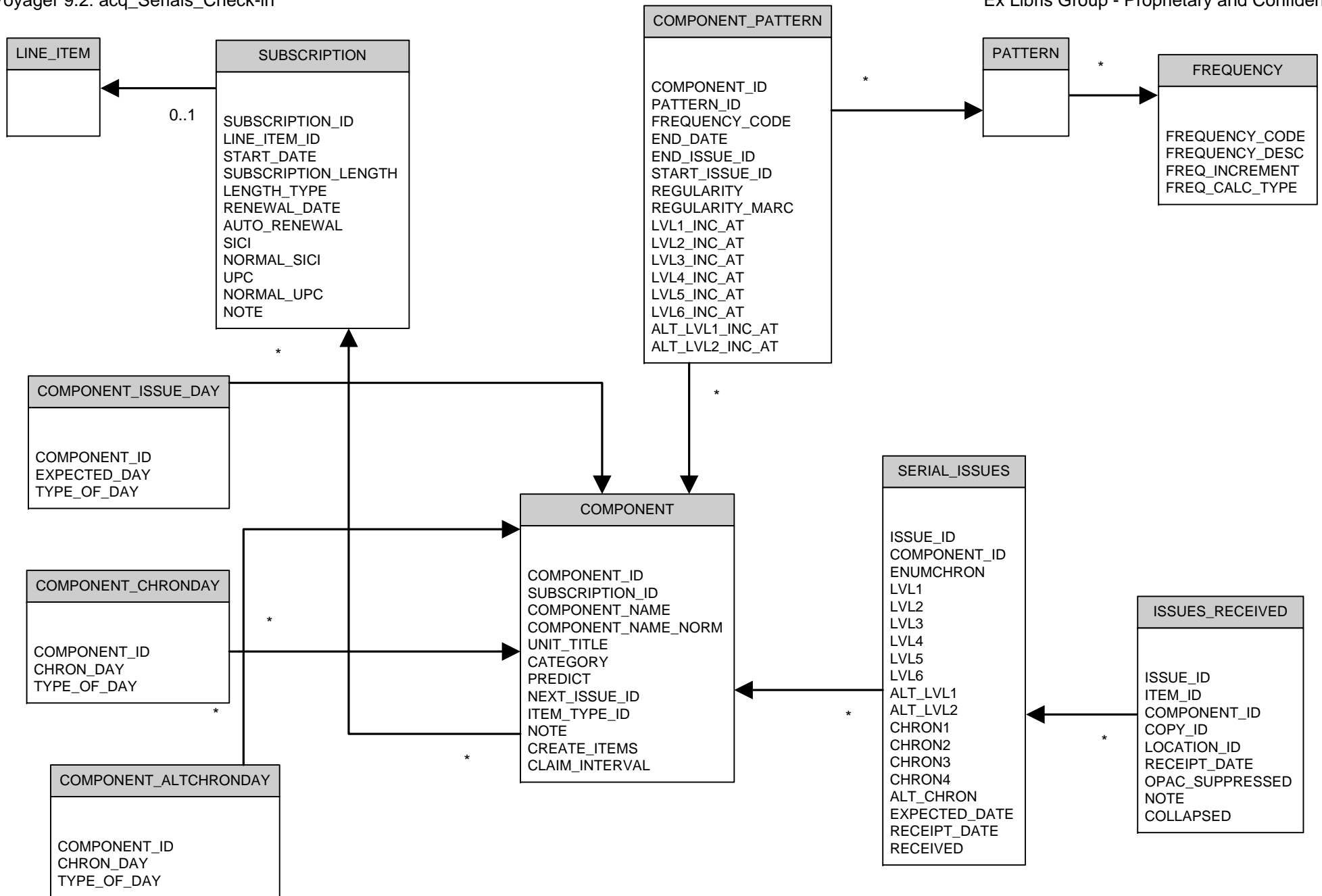

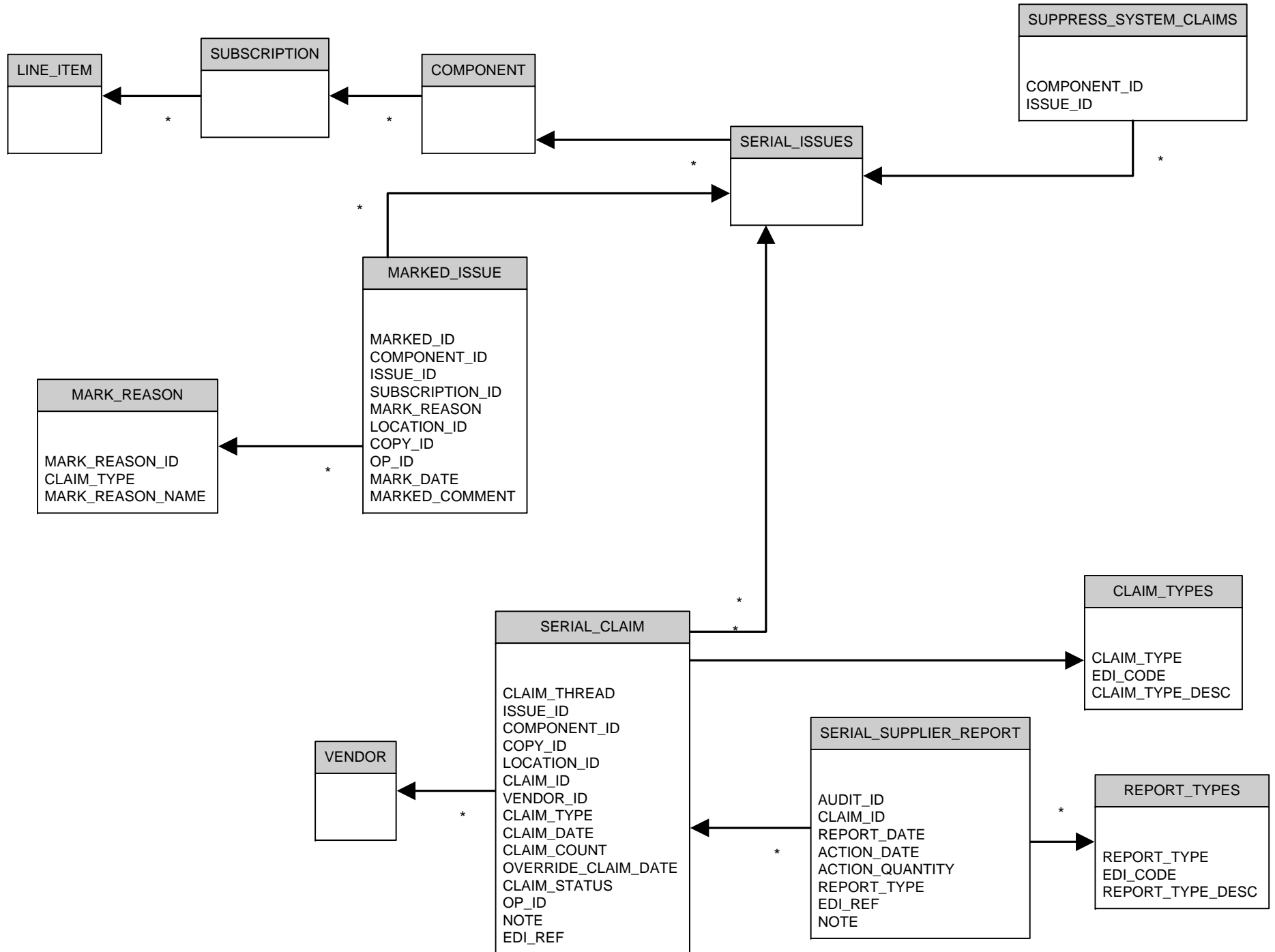

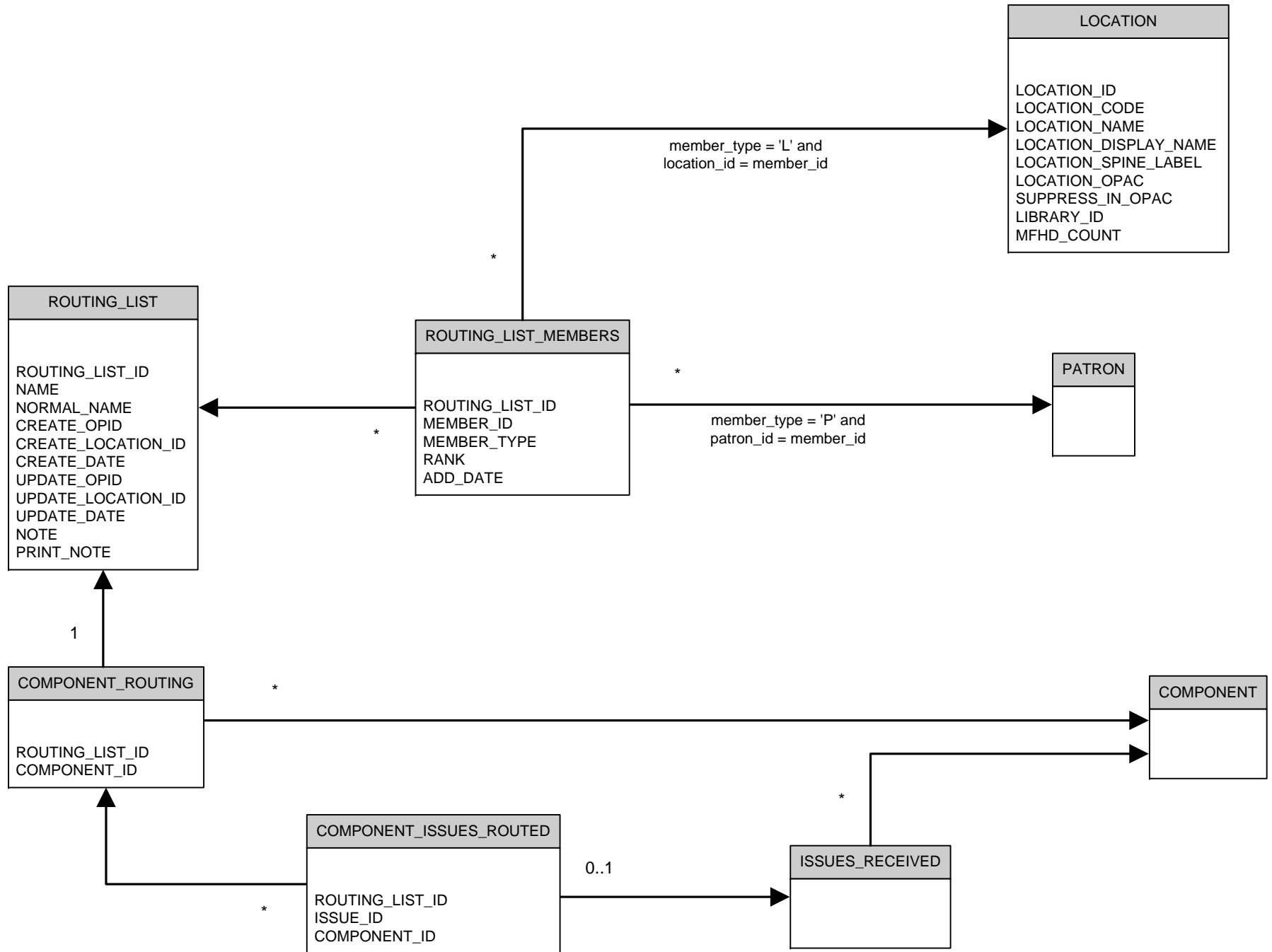

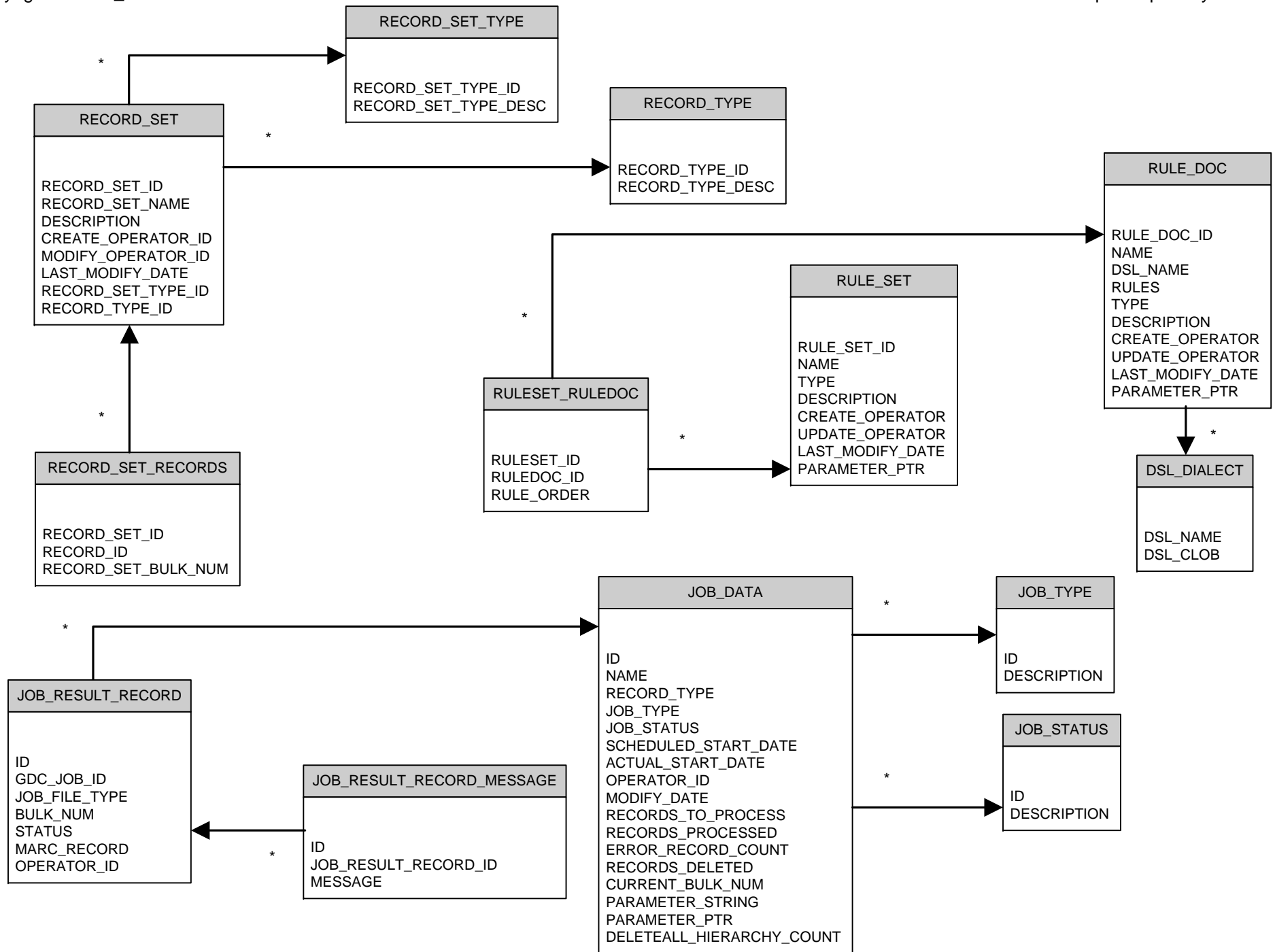

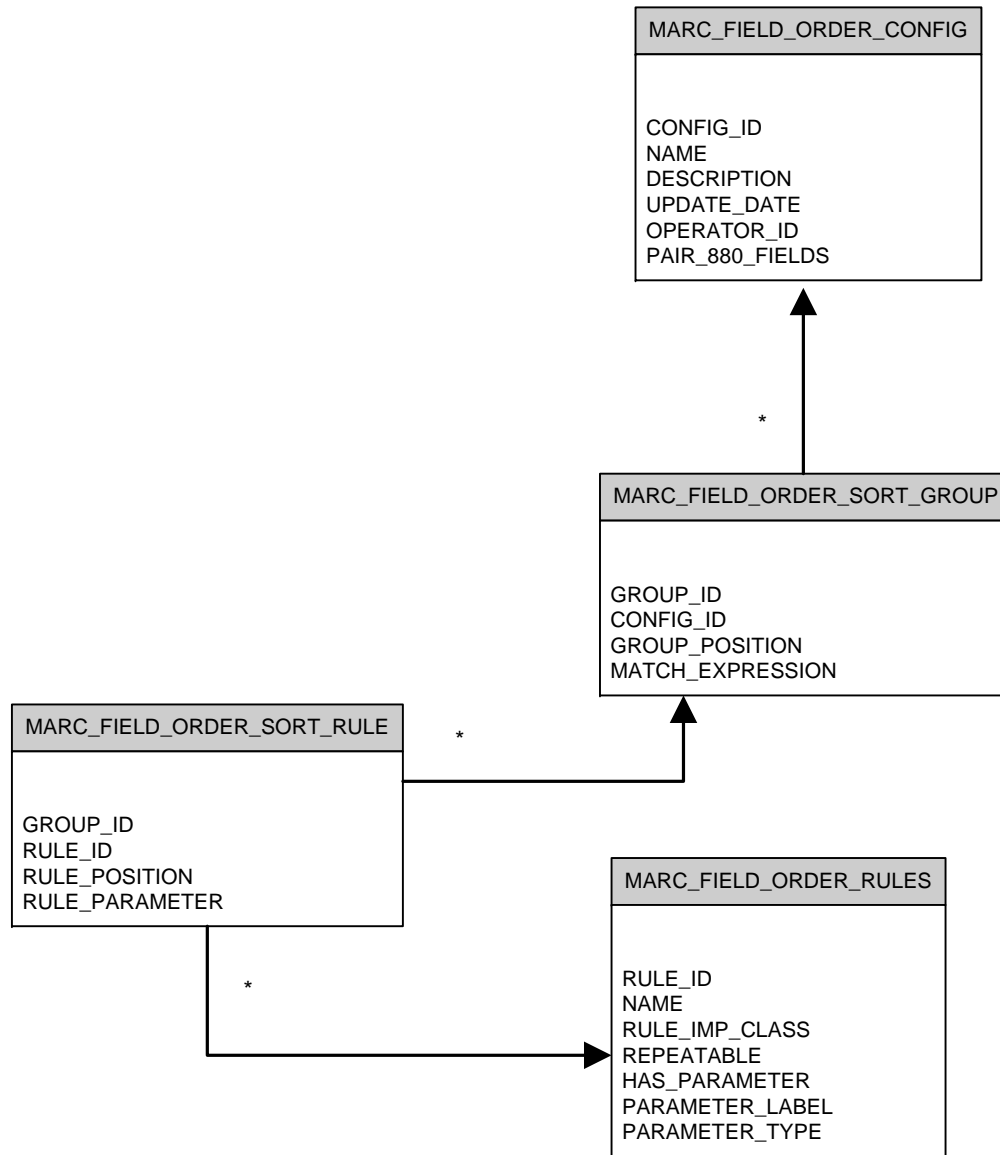

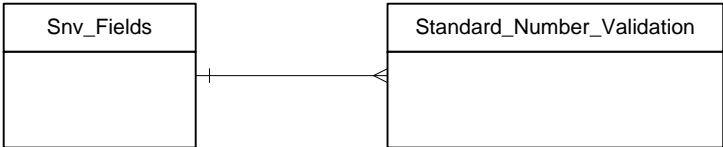

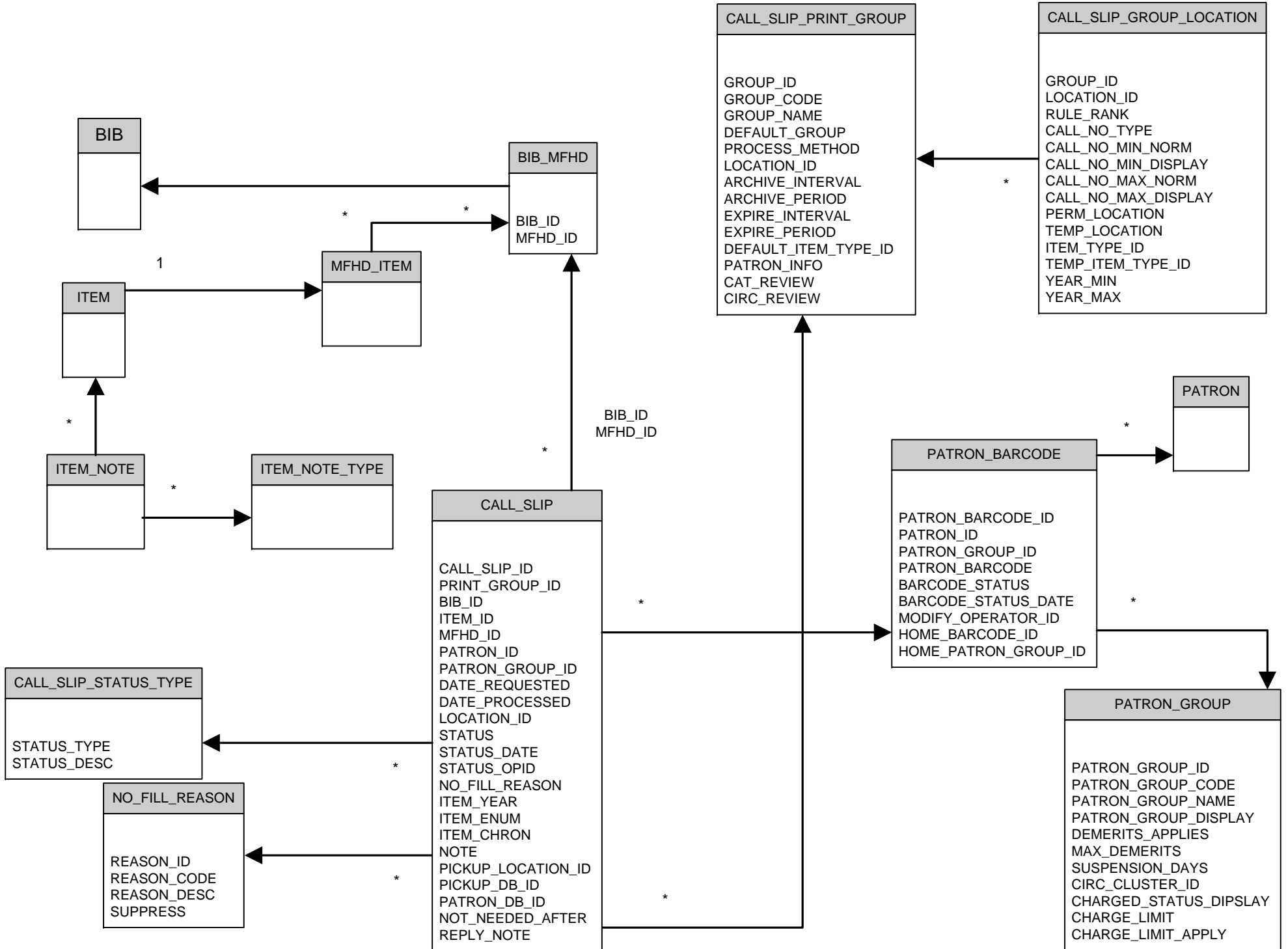

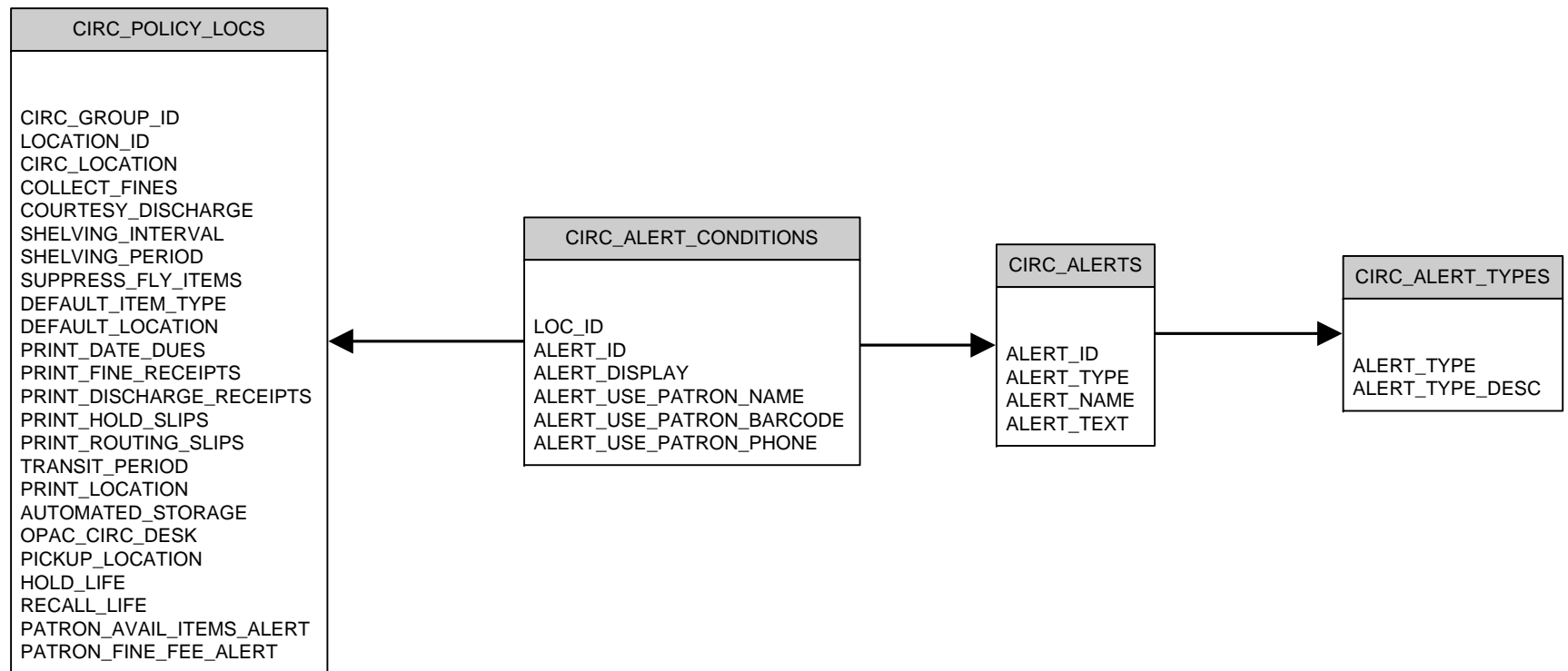

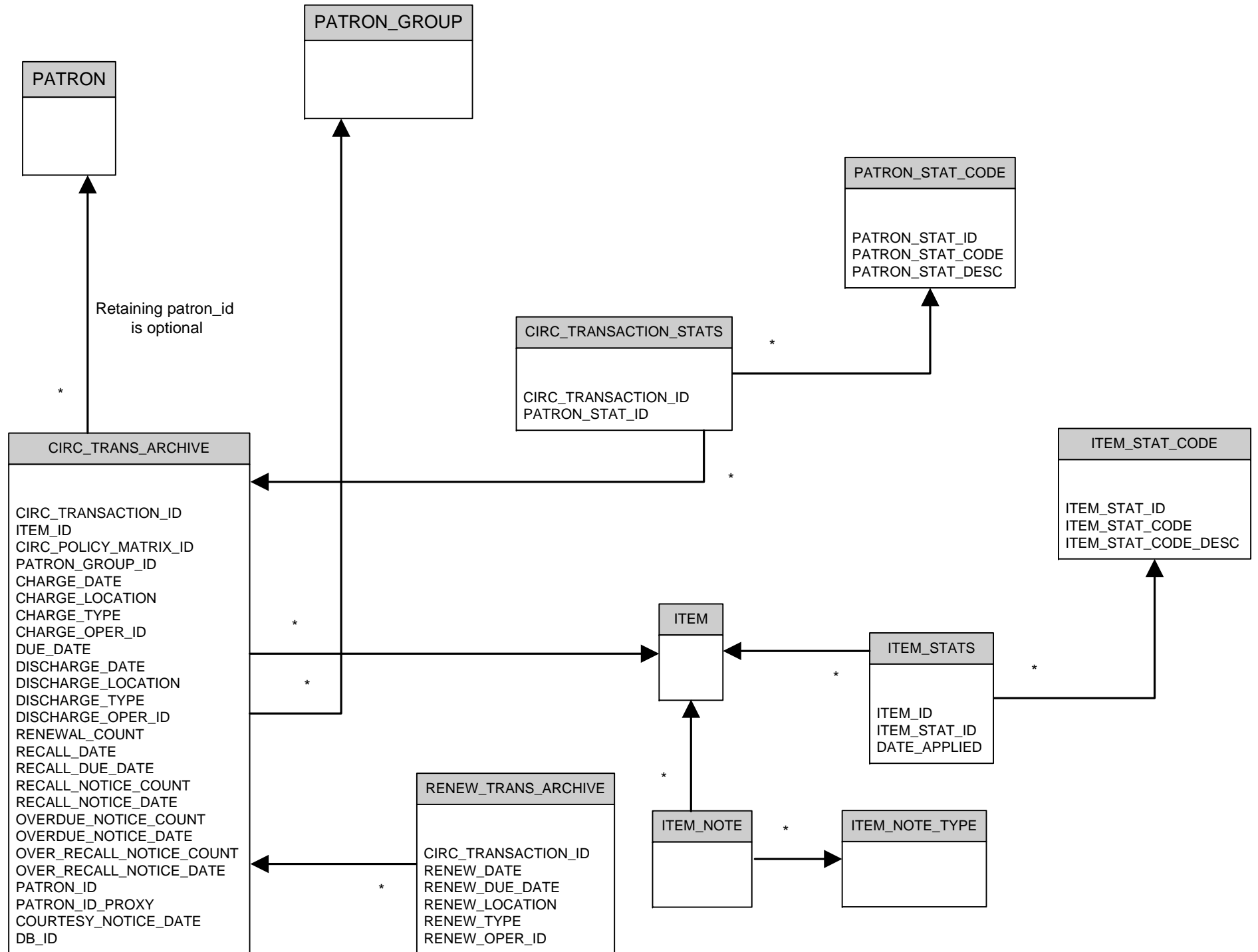

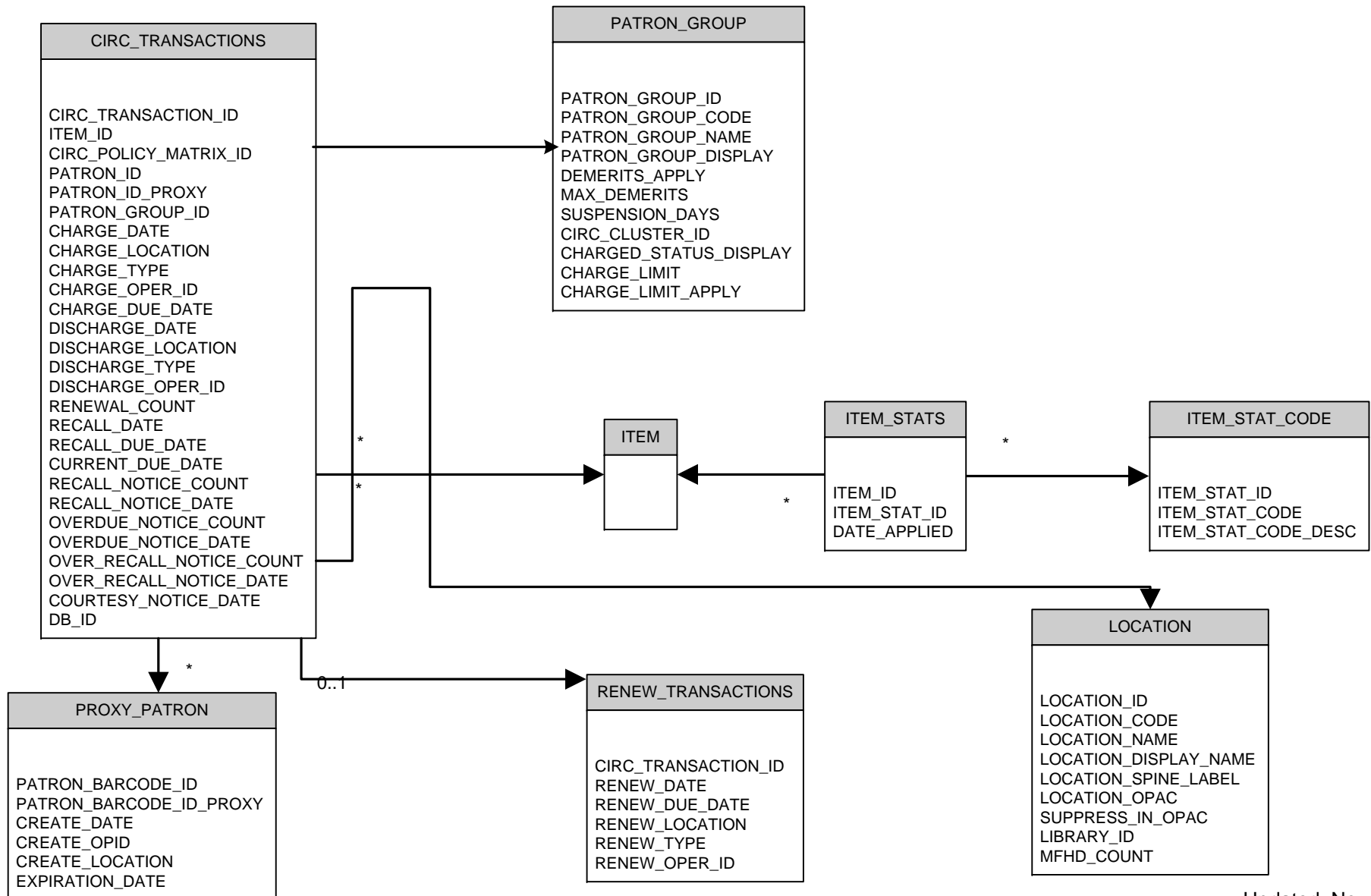

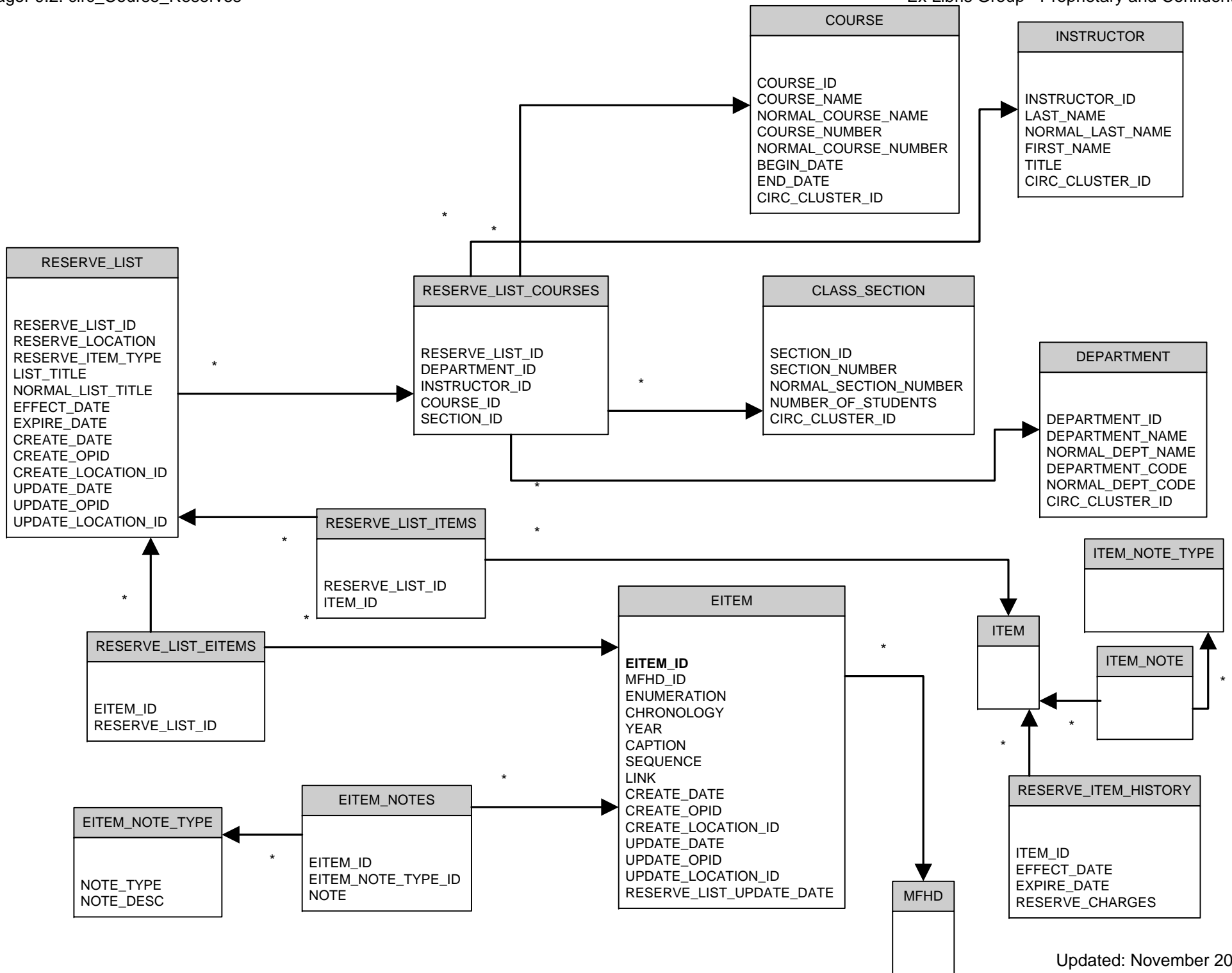

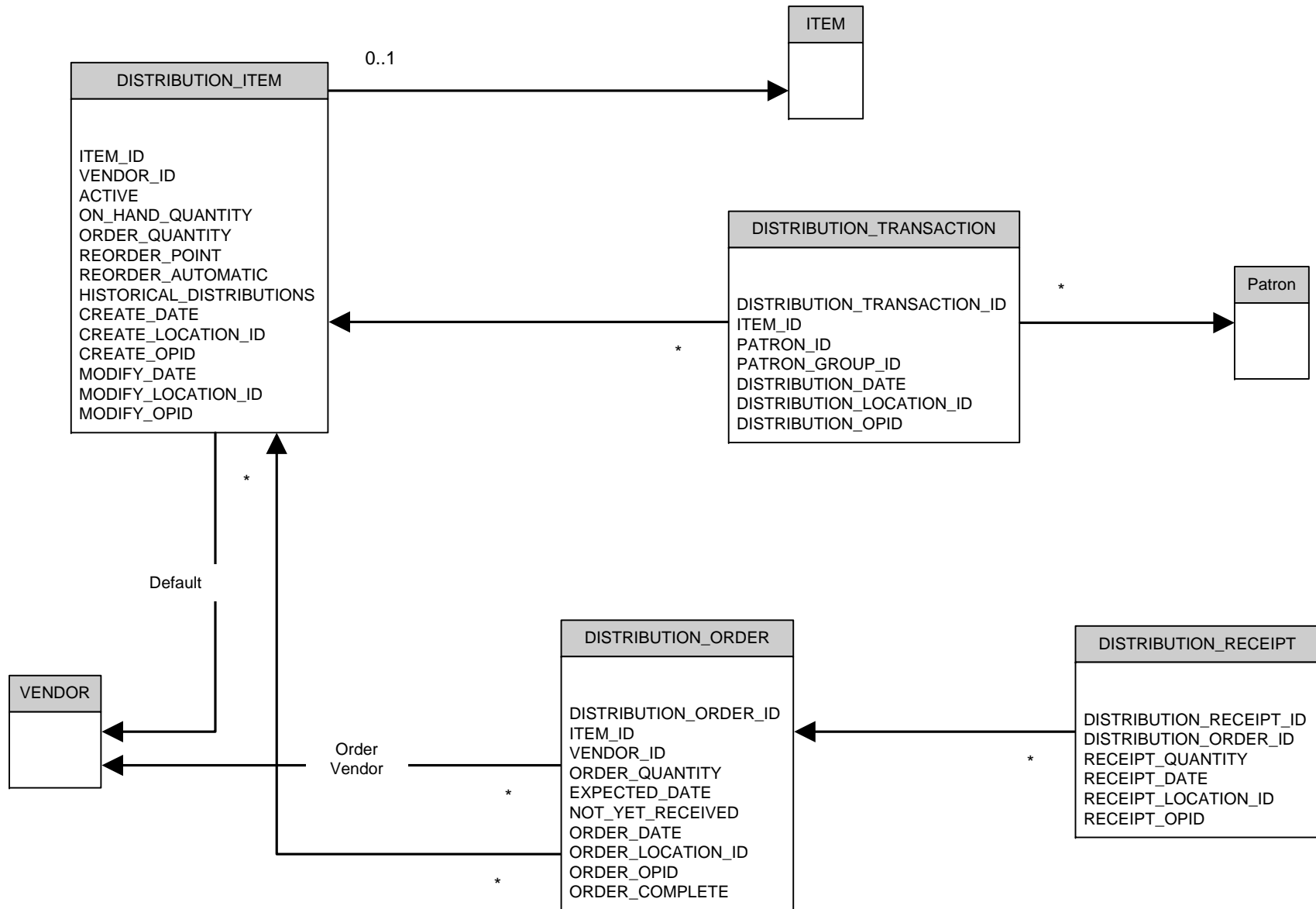

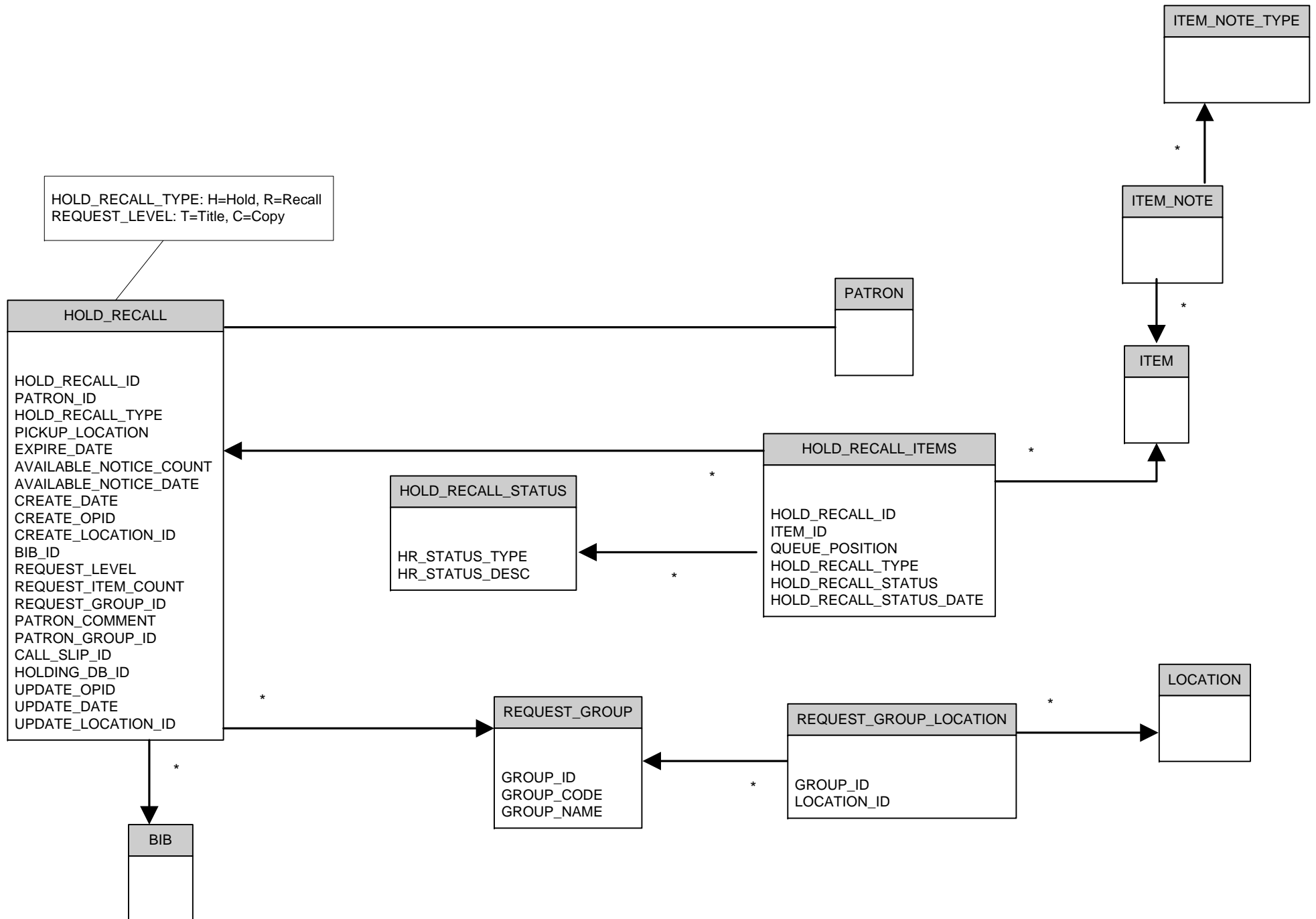

HOLD_RECALL_TYPE: H=Hold, R=Recall
 REQUEST_LEVEL: T=Title, C=Copy

